

PROUDLY MADE IN NZ BY



# Generation 2 NZ Timber Cladding Systems



## BEVELBACK PROFILES 6.3M LENGTHS

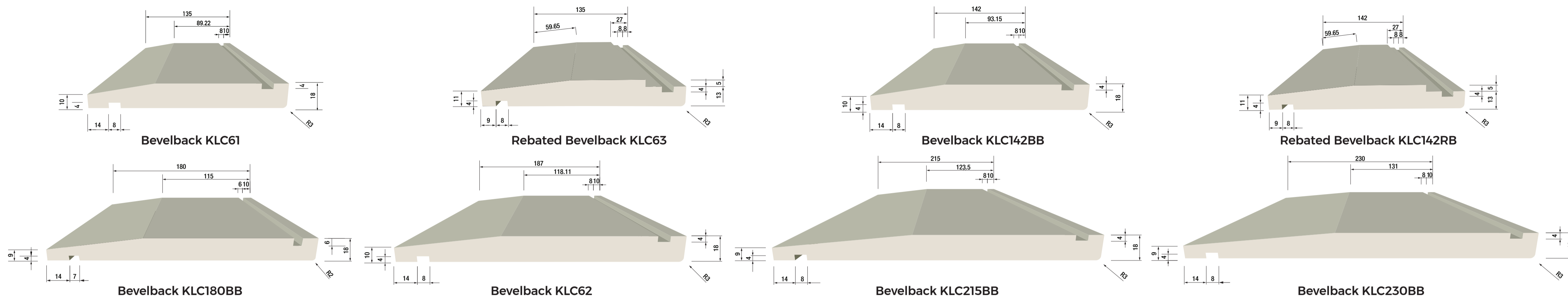

## VERTICAL SHIPLAP PROFILES 6.3M LENGTHS

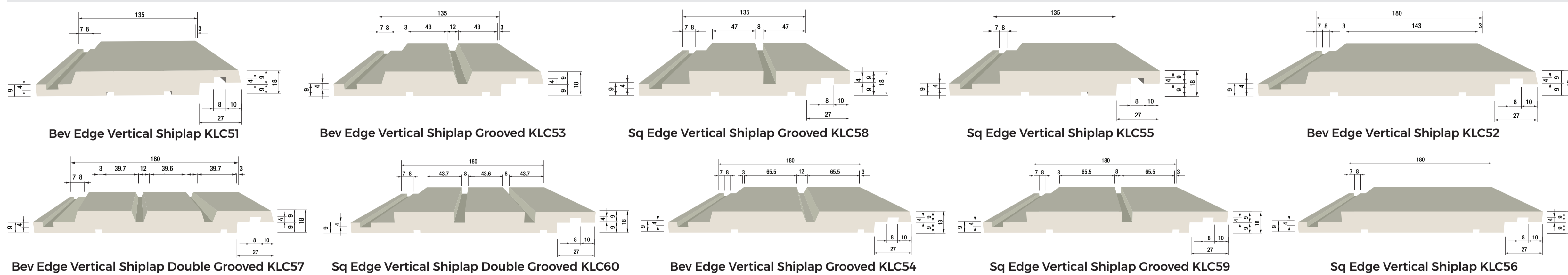

## RUSTICATED PROFILES 6.3M LENGTHS

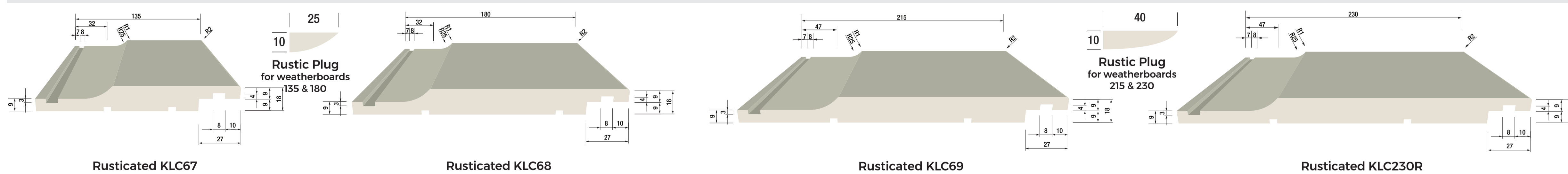

## SPLAYCUT PROFILES 6.3M LENGTHS

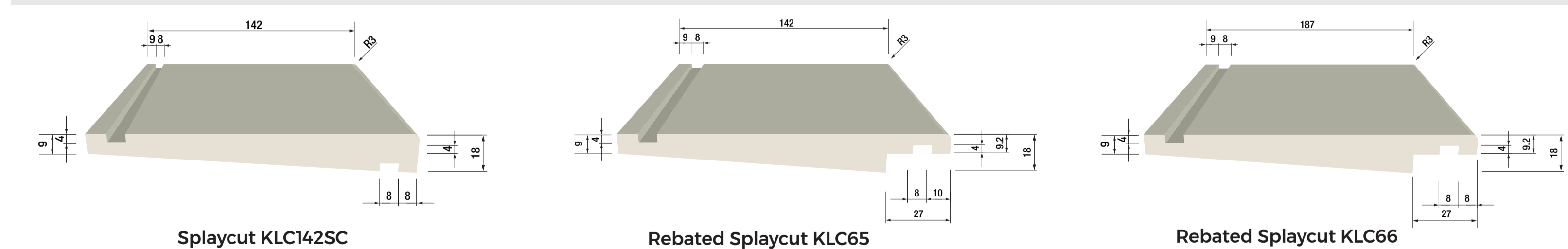

## VERTICAL BOARD & BATTEN PROFILES 6.3M LENGTHS

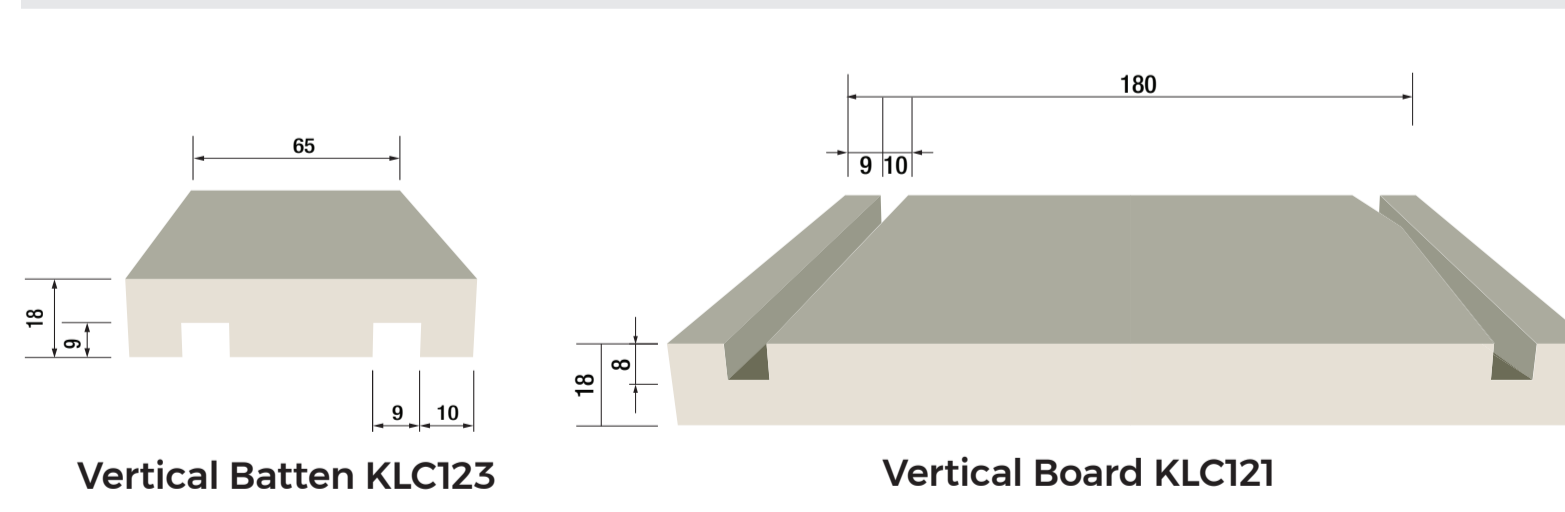

## EXTRA PROFILES FASCIA, BOX CORNERS, D4S AND SCRIBERS

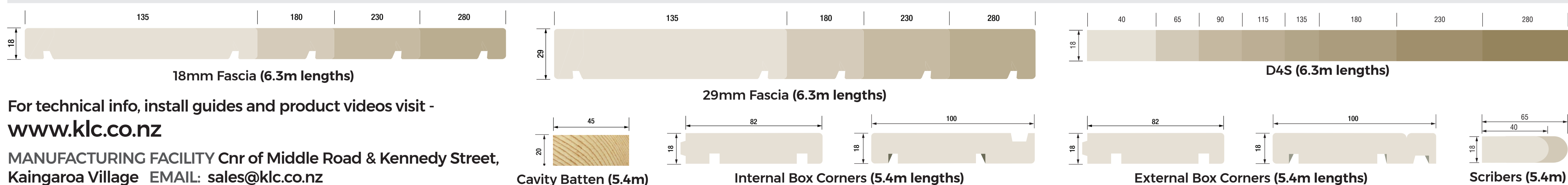

## FENCE SYSTEM COMPONENTS

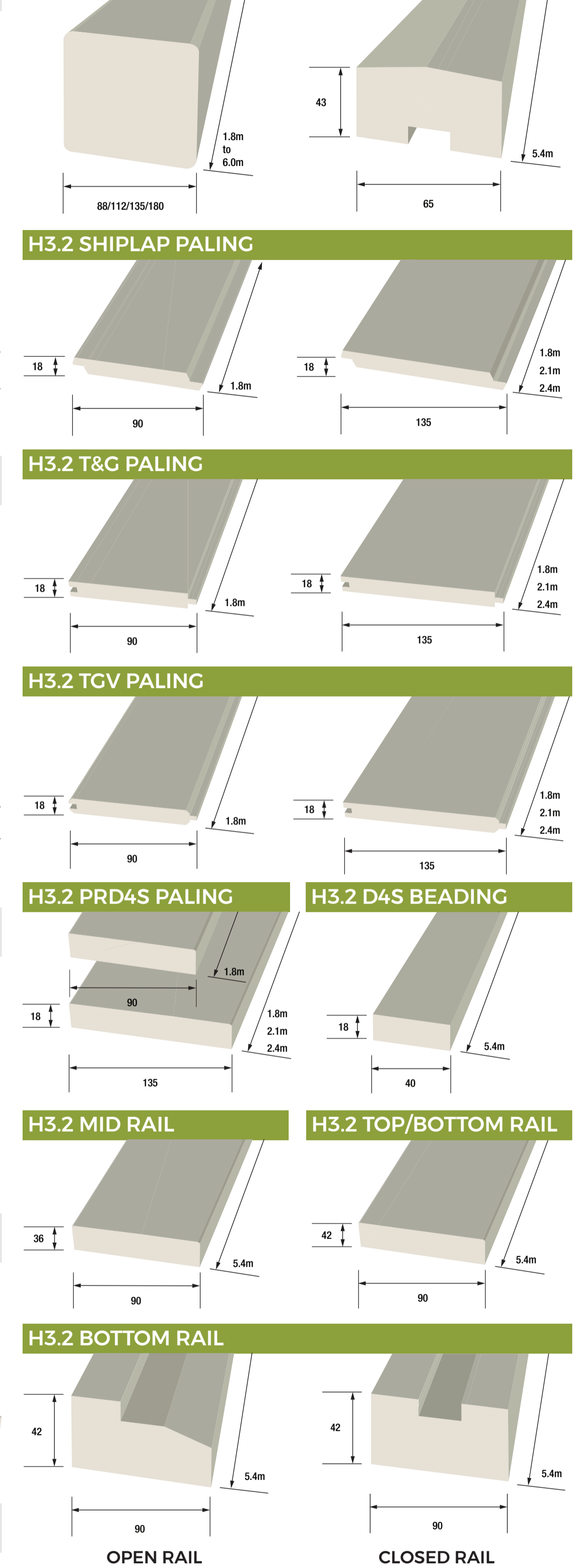

For technical info, install guides and product videos visit - [www.klc.co.nz](http://www.klc.co.nz)

MANUFACTURING FACILITY Cnr of Middle Road & Kennedy Street, Kaingaroa Village EMAIL: [sales@klc.co.nz](mailto:sales@klc.co.nz)

